

PARTS FOR  
EDISON'S PHONOGRAPH

BASED ON AN ARTICLE BY  
DONALD W. MATTESON  
ORIGINALLY PUBLISHED BY  
THE EDISON INSTITUTE  
1977

BIZARRELABS.COM  
2004

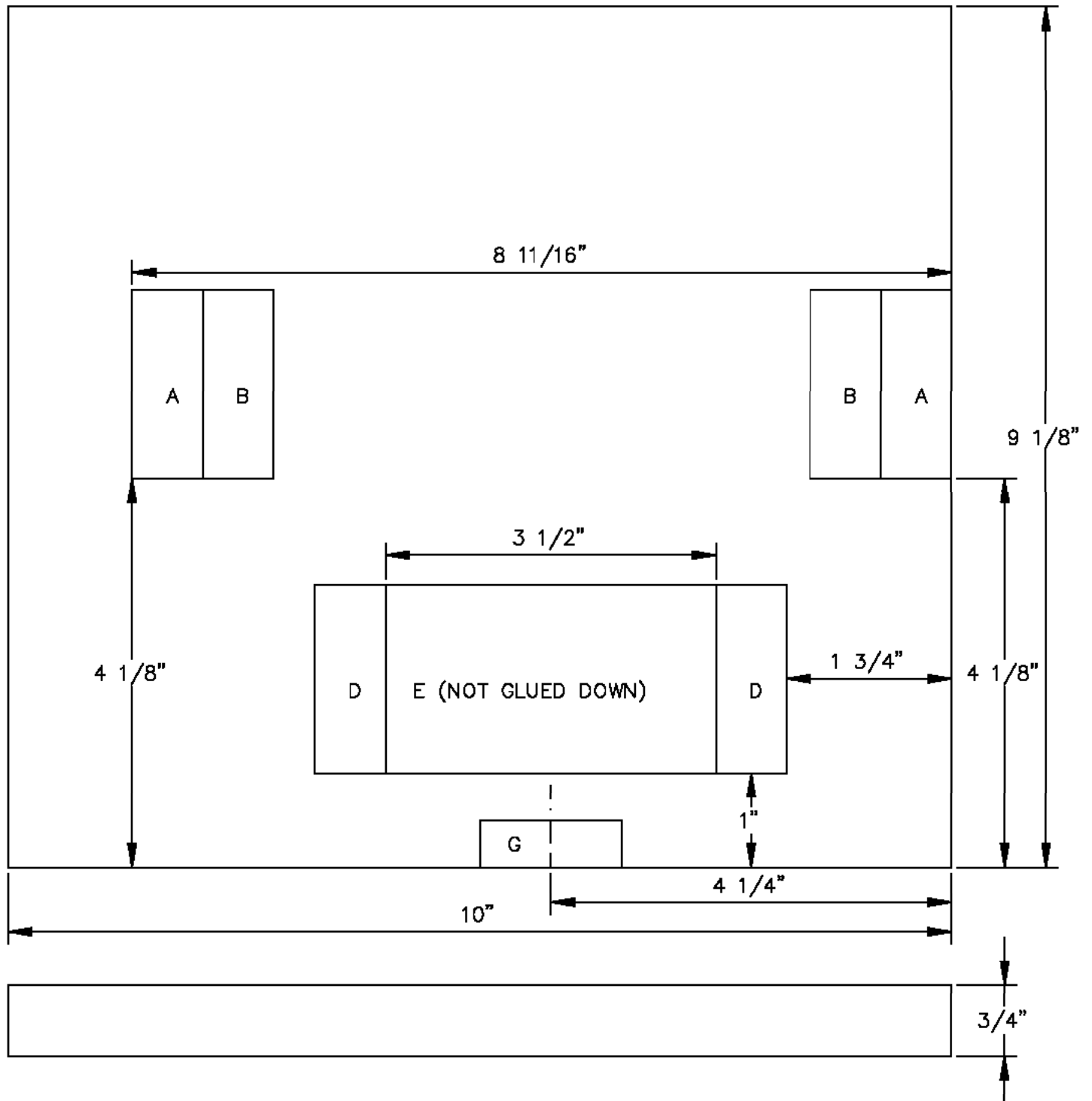

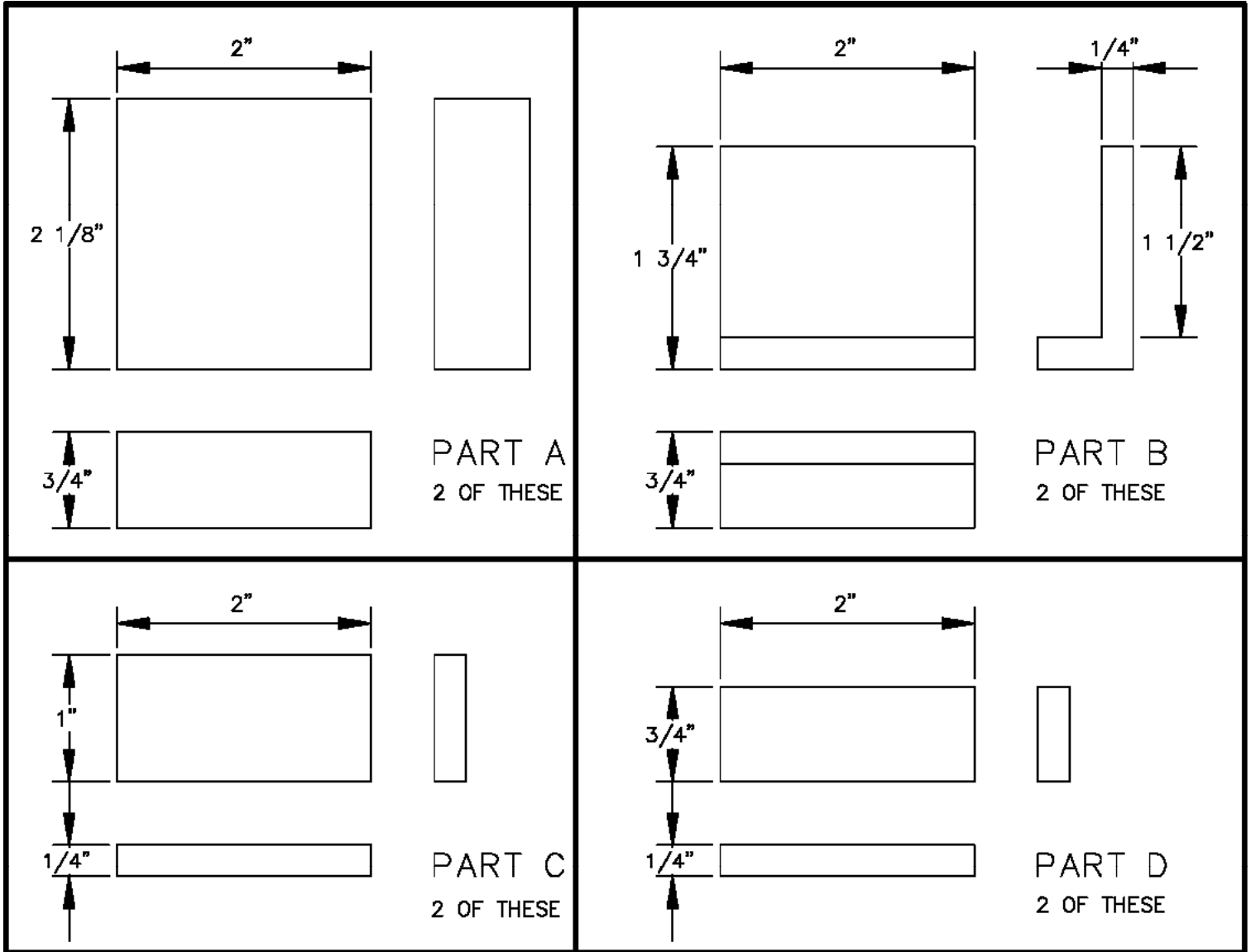

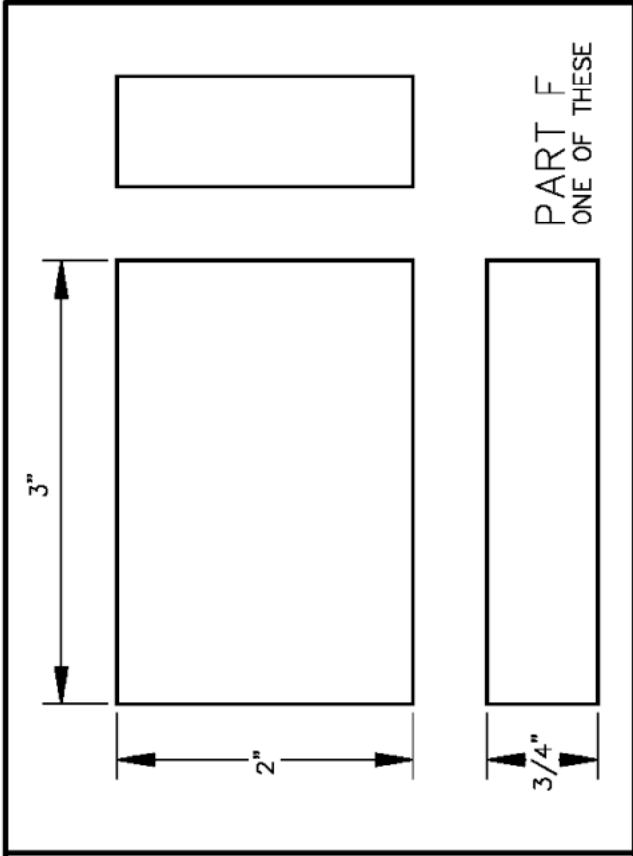

PHONOGRAPH PAGE 3  
MISC SUPPORTS  
2004 BIZARRELABS.COM

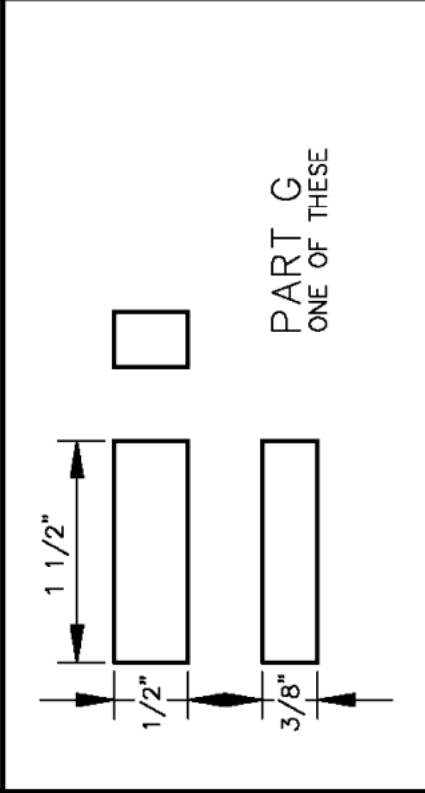
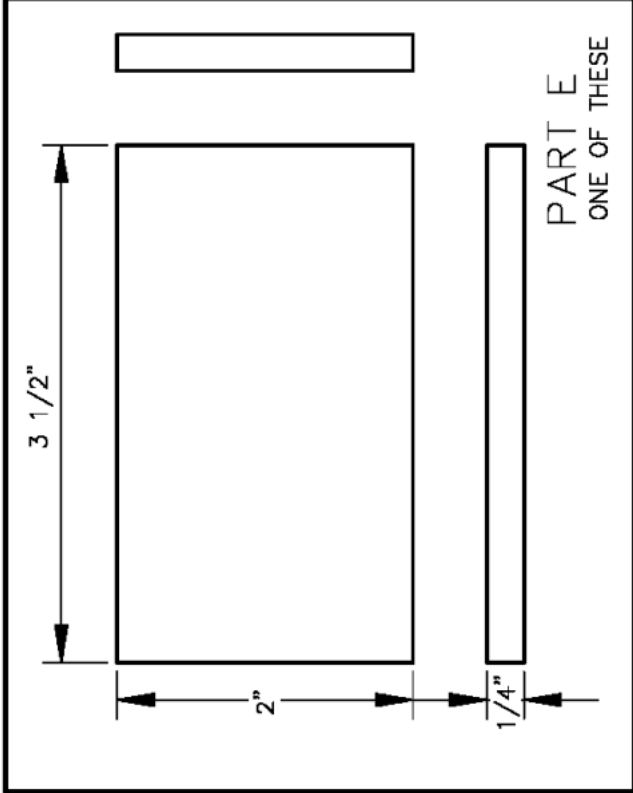

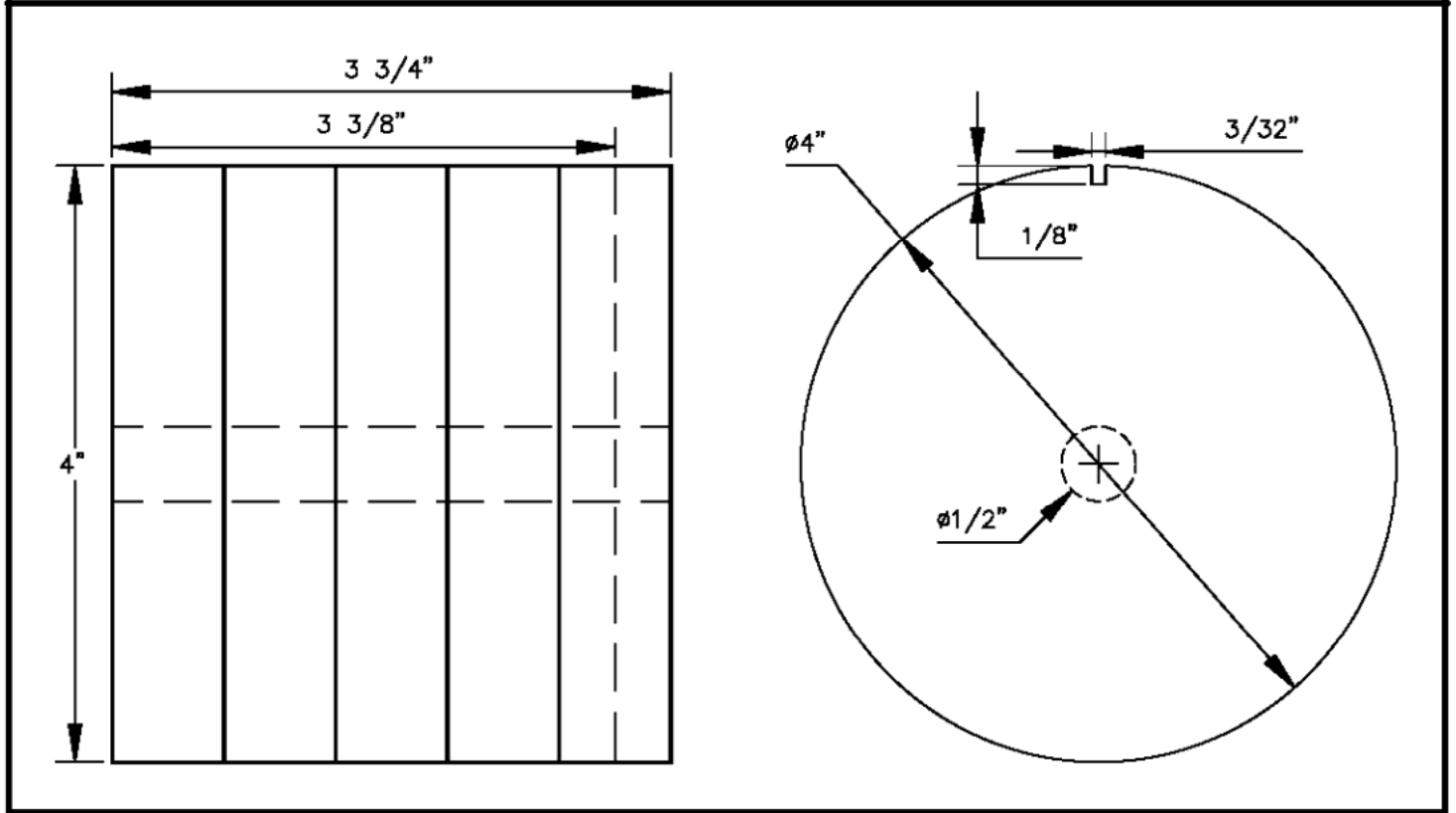
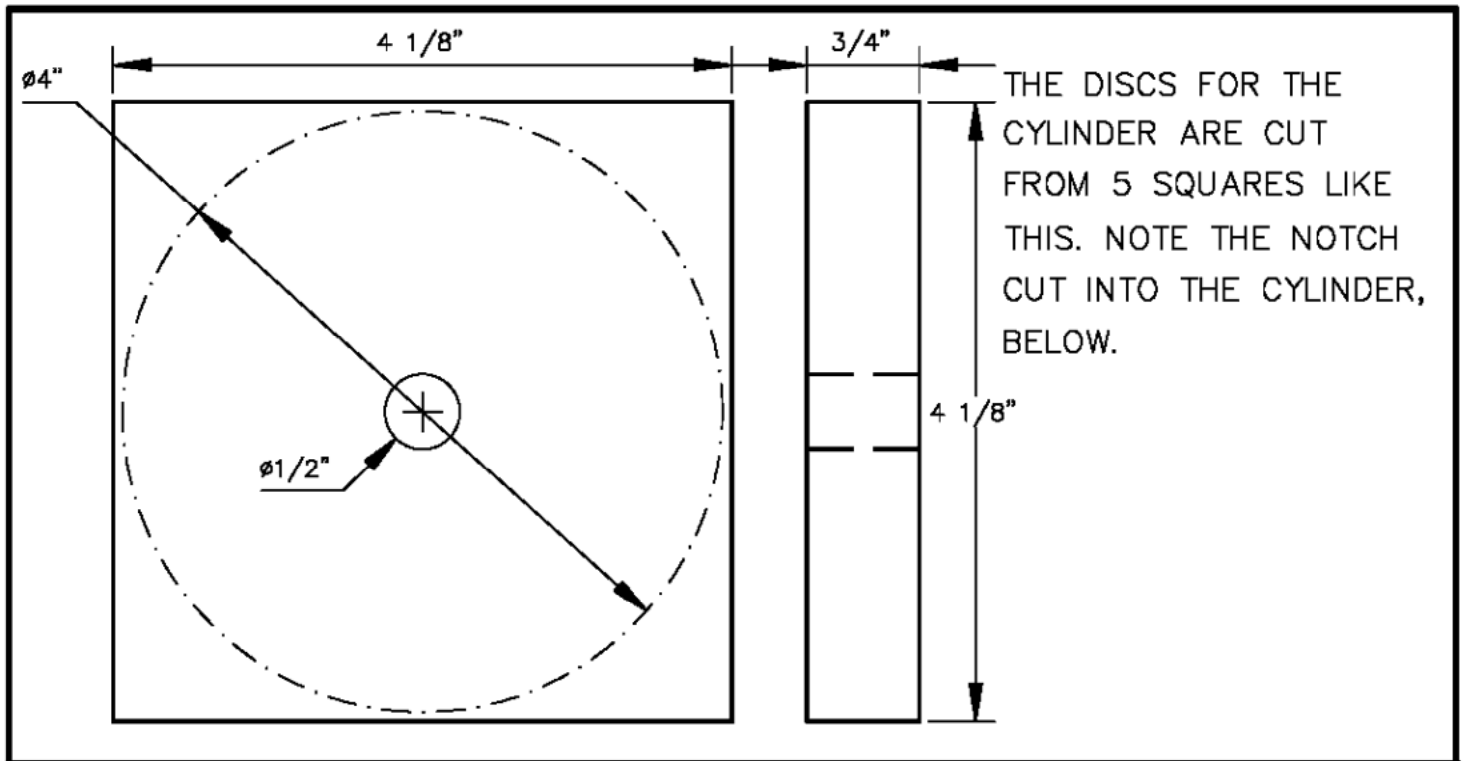

PHONOGRAPH PAGE 5

